



Grayhill, Inc.

## 62S11-H9-060SH

Номер на частта:

62S11-H9-060SH

Производител / марка:

Grayhill, Inc.

Описание на продукта

ROTARY ENCODER OPTICAL 32PPR

Информационни листове:

 62S11-H9-060SH.pdf

Статус на RoHS

 Без олово / RoHS съвместим

Кораб от

Хонг Конг

Път на превоза

DHL/Fedex/TNT/UPS/EMS

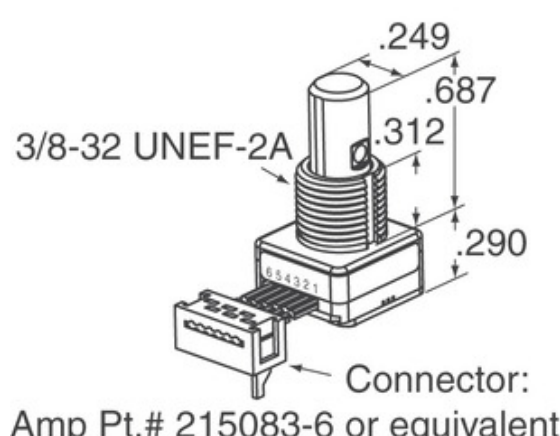

Изображението може да е представяне. Вижте спецификациите за подробности за продукта.

[ЗАПИТВАНЕ ЗА ОФЕРТА](#)



### Спецификации на 62S11-H9-060SH

НОМЕР НА ЧАСТТА	62S11-H9-060SH
ПРОИЗВОДИТЕЛ	Grayhill, Inc.
ОПИСАНИЕ	ROTARY ENCODER OPTICAL 32PPR
СТАТУС ЗА СВОБОДНО СЪСТОЯНИЕ / СЪСТОЯНИЕ НА ROHS	Без олово / RoHS съвместим
ИНФОРМАЦИОНЕН ЛИСТ	 62S11-H9-060SH.pdf
НАПРЕЖЕНИЕ - ДОСТАВКА	5V
СТИЛ НА ПРЕКРАТЯВАНЕ	Cable Leads
СЕРИЯ	62S
РОТАЦИОНЕН ЖИВОТ (ЦИКЛИ МИН.)	1M
ИМПУЛСИ НА РЕВОЛЮЦИЯ	32
ТИП НА ИЗХОДА	Quadrature (Incremental)
ДРУГИ ИМЕНА	62S11H9060SH
ОРИЕНТАЦИЯ	Vertical
ТИП МОНТАЖ	Panel Mount
НИВО НА ЧУВСТВИТЕЛНОСТ КЪМ ВЛАГА (MSL)	1 (Unlimited)
ПРОИЗВОДИТЕЛ СТАНДАРТНО ВРЕМЕ ЗА ДОСТАВКА	8 Weeks
СТАТУС ЗА СВОБОДНО СЪСТОЯНИЕ / СЪСТОЯНИЕ НА ROHS	Lead free / RoHS Compliant
ТИП ЕНКОДЕР	Optical
ОГРАНИЧИТЕЛ	Yes
ВГРАДЕН SWITCH	Yes
ТИП НА ЗАДВИЖВАНЕТО	1/4" Dia Flatted End

### Свързани маркери

Grayhill, Inc. 62S11-H9-060SH	62S11-H9-060SH дистрибутор	Доставчик на 62S11-H9-060SH
62S11-H9-060SH Цена	62S11-H9-060SH снимки	Образ на 62S11-H9-060SH
62S11-H9-060SH PDF лист с данни	62S11-H9-060SH Изтеглете лист с данни	62S11-H9-060SH Лист с данни
62S11-H9-060SH склад	Купете 62S11-H9-060SH	Купете Grayhill, Inc. 62S11-H9-060SH
Grayhill, Inc. 62S11-H9-060SH	Доставчик на Grayhill, Inc.	Grayhill, Inc. дистрибутор
Grayhill, Inc. 62S11-H9-060SH	Grayhill Inc. 62S11-H9-060SH	

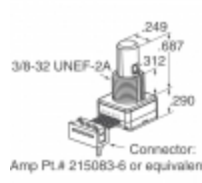
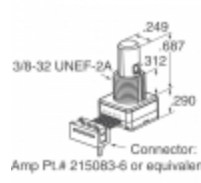
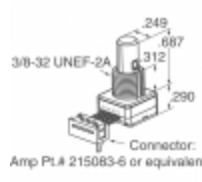
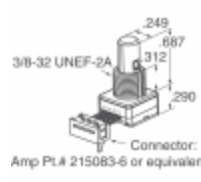
### Свързани продукти

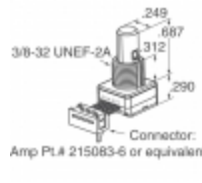
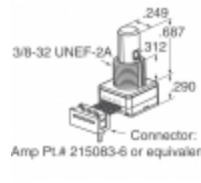
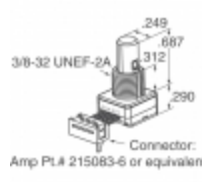
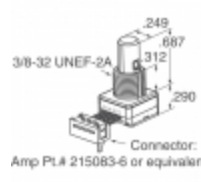
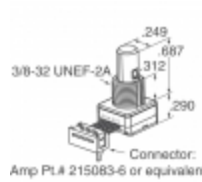
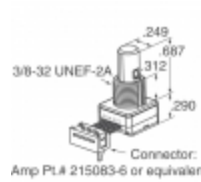
 <p><b>62S11-L0-040C</b> Производители: Grayhill, Inc. описание: ROTARY ENCODER OPTICAL 32PPR В наличност: Out stock</p> <p><a href="#">RFQ</a></p>	 <p><b>62S11-H9-050S</b> Производители: Grayhill, Inc. описание: ROTARY ENCODER OPTICAL 32PPR В наличност: Out stock</p> <p><a href="#">RFQ</a></p>
 <p><b>62S11-L0-020C</b> Производители: Grayhill, Inc. описание: ROTARY ENCODER OPTICAL 32PPR В наличност: Out stock</p> <p><a href="#">RFQ</a></p>	 <p><b>62S11-L0-020CH</b> Производители: Grayhill, Inc. описание: ROTARY ENCODER OPTICAL 32PPR В наличност: Out stock</p> <p><a href="#">RFQ</a></p>
 <p><b>62S11-L0-040S</b> Производители: Grayhill, Inc. описание: ROTARY ENCODER OPT 32PPR 4" CBL В наличност: Out stock</p> <p><a href="#">RFQ</a></p>	 <p><b>62S11-H9-040S</b> Производители: Grayhill, Inc. описание: ROTARY ENCODER OPTICAL 32PPR В наличност: Out stock</p> <p><a href="#">RFQ</a></p>
 <p><b>62S11-H9-020S</b> Производители: Grayhill, Inc. описание: ROTARY ENCODER OPTICAL 32PPR В наличност: Out stock</p> <p><a href="#">RFQ</a></p>	 <p><b>62S11-H9-P</b> Производители: Grayhill, Inc. описание: ROTARY ENCODER OPTICAL 32PPR В наличност: Out stock</p> <p><a href="#">RFQ</a></p>
 <p><b>62S11-H9-PH</b> Производители: Grayhill, Inc. описание: ROTARY ENCODER OPTICAL 32PPR В наличност: Out stock</p> <p><a href="#">RFQ</a></p>	 <p><b>62S11-H9-025S</b> Производители: Grayhill, Inc. описание: ROTARY ENCODER OPTICAL 32PPR В наличност: Out stock</p> <p><a href="#">RFQ</a></p>
 <p><b>62S11-H9-060C</b> Производители: Grayhill, Inc. описание: ROTARY ENCODER OPTICAL 32PPR В наличност: Out stock</p> <p><a href="#">RFQ</a></p>	 <p><b>62S11-H9-040C</b> Производители: Grayhill, Inc. описание: ROTARY ENCODER OPTICAL 32PPR В наличност: Out stock</p> <p><a href="#">RFQ</a></p>